

OLYMPIA ® Protect 9XXX Series Wireless Alarm System



Instruction Manual

17.12.2012 en

Olympia Business Systems Vertriebs GmbH
Zum Kraftwerk 1
45527 Hattingen

Introduction	5	Operating Elements and Indicators	14
Warranty	5	Function Assignment to Buttons, Base Unit	14
User Information	5	Display Icons	15
Disclaimer of Liability	5	Overview of LEDs	16
Intended Use	5	Function Assignment to Buttons, Remote Control	16
Product Features	6	Menu Structure	17
Scope of Delivery	6	Configuration	19
Safety Information	7	General Information	19
Significance of the Symbols	7	Selecting the Language	19
Important Safety Information	7	Entry Code	19
GSM Telephone Dialling Unit	8	Setting the Date/Time	20
Function of the GSM Telephone Dialling Unit	8	Individual Outgoing Messages	20
SIM Card	8	Activating the GSM Internal Telephone Dialling Unit with OGM Function 21	21
Unlocking the SIM Card	8	Saving an SOS (Emergency Call) Number	22
Reminder Function	9	Trigger Delay	23
Checking the Credit Status	9	Arming Delay	23
Preventing the SIM Card Being Locked	9	Alarm Period	24
Installation	10	Key Tone On/Off	24
Information on Selecting the Installation Location	10	Setting the Display Contrast	24
Preparing and Connecting the Base Unit	11	Remote Control	25
Testing the GSM Telephone Dialling Unit	12	Flood and Smoke Detectors	25
Positioning the Base Unit	12	Overview of Monitoring Functions	26
Wall Installation	13		

Contents

Switching the Monitoring Functions On/Off	26	Information on Disposal	34
Alarm Mode	27	Technical Data	35
At Home Mode	27	Base Unit	35
Silent Mode	27	Remote Control	35
Disarmed Mode	28	Technical Modifications	35
Panic Alarm	28	CE Mark	36
Emergency Call (SOS)	28		
Remote Access Via Telephone	29		
Resetting the Factory Settings (RESET)	30		
Registering Sensors	31		
Deregistering Sensors	31		
System Extension	31		
Changing the Batteries	32		
Remote Control	32		
Base Unit	32		
Regular Maintenance and Servicing	33		
Base Unit	33		

Introduction

Warranty

Dear Customer,
we are pleased that you have chosen this equipment.

In the case of a defect, please return the device together with the receipt and original packing material to the point-of-sale.

User Information

The alarm system is a passive security product and has been conceived as a deterrent. Additional measures are necessary to prevent and hinder burglary and theft. You can obtain all the necessary information on this from your local police station.

Read the operating instruction manual thoroughly before connecting and starting the system for the first time. The operating instruction manual will help prevent application errors and, at the same time, ensure you can exploit all the technical options provided by the wireless alarm system to the full.

Disclaimer of Liability

We cannot guarantee that the information which relates to the technical properties of the product or to the product itself contained in this document is correct. The product and its accessories described in this document are subject to constant improvement and further development. For this reason, we reserve the right to modify components, accessories, technical specifications and related documentation of the product described herein at any time without notice.

Intended Use

The wireless alarm systems from the Protect 9XXX-Series enable you to monitor rooms and buildings as long as the local conditions are such that they enable a reliable transmission link to the sensors (e.g. door/window contact, smoke detector). In addition, all doors and windows must be equipped with door/window contacts. A condition for complying with the intended use is that the equipment is installed correctly and the information in this operating instruction manual is observed and maintained.

Any other use is considered unintended use. Unauthorised modifications or reconstructions not described in this operating instruction manual are not permitted and could cause the product to be damaged. Furthermore, risks through short-circuits, fire, electric shock etc. cannot be ruled out.

Product Features / Scope of Delivery

Product Features

- Wireless alarm system with emergency call, panic, screening and handsfree functions.
- Transmit function to activate outdoor sirens etc.
- Integrated GSM telephone dialling unit with outgoing message for alarm messages via the mobile network.
- Up to 10 alarm call numbers and 1 emergency call number (SOS) can be stored.
- Messages for alarm calls can be set up individually for each respective sensor, up to max. 10 seconds long.
- Automatic dialling of the next number when the number called is "engaged".
- Handsfree function on the base unit in the case of an SOS.
- Telephone (silent) alarm/siren alarm can be set individually or combined.
- Large LC display, 1 numeric line in 7 segments for 24 characters, 1 alphanumeric line in 5x7 dot matrix for 13 characters, 11 icons as status indicators.
- Display lighting in yellow and blue.
- Warning in the event of a low battery charge status (base unit and all registered sensors).
- Power failure backup in the base unit.
- Base unit has a remote control facility.
- Upgradable for operation with max. 32 sensors.
- Simple integration of new sensors/smoke detectors, Plug-and-Play.

Scope of Delivery

Base unit	1
Power adapter plug	1
Remote control	1
Batteries	3x alkaline AAA 1x lithium CR2430 3 V
Assembly material	Screws, dowels, adhesive tape
Operating instructions	1

Please check the contents of the package carefully. If anything is missing or has been damaged during transport, DO NOT put the wireless alarm system into operation! In such cases, contact your sales outlet, with your purchase receipt to hand, or the OLYMPIA service centre.



NOTE:

Keep the packaging in a safe place to protect the equipment from damage should it need to be dispatched in future.



NOTE:

This operating instruction manual relates to the base unit of the alarm system. The sensors are described in separate manuals.

Safety Information

Significance of the Symbols



WARNING:

Indicates potentially dangerous situations which could lead to fatal or severe personal injury if the information is ignored.



CAUTION:

Indicates potentially dangerous situations which could lead to minor personal injury if the information is ignored.



NOTE:

Indicates potentially dangerous situations which could lead to property or environmental damage if the information is ignored.

Important Safety Information

Please observe the following safety information to ensure the wireless alarm system can be used safely and reliably:

- If you are uncertain or have any doubts about the functioning method of the equipment during assembly and installation, contact a specialist. In case of doubt, do not complete assembly and installation work yourself.
- Never open the equipment! Never use the device when it is wet or in the vicinity of a bathtub, shower or such!
- Repairs to defective equipment must always be completed by authorised service technicians.
- Never touch the power adapter plug on the base unit with wet or damp hands.
- If the power adapter plug shows signs of damage, disconnect the fuse in the fuse box prior disconnecting the relevant plug from the power socket.
- The wireless alarm system and packaging materials must not be used as toys by children.



NOTE:

This operating instruction manual contains important information on setting up and handling the equipment. The manual must be enclosed with the equipment if handed over to others.

GSM Telephone Dialling Unit

GSM Telephone Dialling Unit

Function of the GSM Telephone Dialling Unit

The GSM telephone dialling unit (dual band, 900/1800 MHz) establishes a connection between the Protect 9XXX-Series alarm system and mobile network. It enables a telephone link to be set up without access to a land-line.

SIM Card

(not included in equipment supplied)

In order to operate the GSM telephone dialling unit you need a SIM card from a mobile phone provider. This is not included in the equipment supplied.



NOTE: The alarm system can also be operated without a SIM card connection. However, in the event of an alarm, there is no alert via the mobile network!

If you use a prepaid card, pay attention to the following:

- The card must be topped up at regular intervals.
- Most prepaid cards must be used at a charge within a certain period of time, otherwise they are blocked. Contact your mobile phone provider for details regarding deadlines.

Unlocking the SIM Card

SIM cards are normally locked against unauthorised use by means of a 4-digit PIN.

When the SIM card is used for the first time, it must be unlocked.

1. If the SIM card is locked against use by a PIN, **SIM Card PIN?** appears in the display.
2. Enter the PIN received together with the SIM card.
3. When the PIN has been entered correctly, **Search...** appears in the display.

The PIN is then permanently deactivated. If you insert the SIM card again or connect the base unit again, the PIN need not be entered.

- If you enter the PIN incorrectly, **Enter again** appears in the display.
- If you enter the PIN incorrectly 3 times, **SIM Locked** appears in the display. In this case, contact your mobile phone provider to unlock the SIM card.
- If the SIM card inserted is not a GSM card, **SIM Error** appears in the display.

Reminder Function

Check SIM \$ appears in the display on 31st March, 30th June, 30th September and 31st December.

Checking the Credit Status

4. When the **Check SIM \$** reminder message appears, enter the device-specific Entry Code. Confirm it by pressing **OK**.
5. **SIM Service #** appears in the display.
6. Enter the service number of the mobile phone provider. Confirm it by pressing **OK**. The service number is dialled.
7. Follow the instructions from the mobile phone provider.
8. Press **OK** to end the call.

You can request the credit status at any time by using the menu.

1. Enter the device-specific Entry Code. Confirm it by pressing **OK**.
2. The menu is opened by pressing the Menu button **▲≡** briefly.
3. Select the **Check SIM \$** menu option. Confirm it by pressing **OK**.
4. **SIM Service #** appears in the display.
5. Enter the service number of the mobile phone provider. Confirm it by pressing **OK**. The service number is dialled.
6. Follow the instructions from the mobile phone provider.
7. Press **OK** to end the call.

Preventing the SIM Card Being Locked

Most prepaid cards must be used at a charge within a certain period of time, otherwise they are blocked. You can use the function requesting the credit status to make a call liable for costs.



NOTE:

Contact your mobile phone provider for details regarding time limits within which prepaid cards must be used.

1. Enter the device-specific Entry Code. Confirm it by pressing **OK**.
2. The menu is opened by pressing the Menu button **▲≡** briefly.
3. Select the **Check SIM \$** menu option. Confirm it by pressing **OK**.
4. **SIM Service #** appears in the display.
5. Enter the number of your conventional phone or mobile phone. Confirm it by pressing **OK**. The number is dialled.
6. Take the call on your conventional phone or mobile phone.
7. Press **OK** to end the call.

Installation

Installation

Information on Selecting the Installation Location

- The base unit should be installed or positioned in a central location (e.g. in the hallway of an apartment/house) in relation to the area to be monitored in order to keep all transmission paths as short as possible.
- Place the base unit in a location where a properly installed power socket (230 V / 50 Hz) is available.
- Ensure that the base unit can receive a sufficiently powerful signal from the mobile network.
- Choose a location within the area being monitored to ensure that no intruders can approach the base unit and manipulate it.
- The base unit and power adapter plug must not be used in damp rooms (cellar, bathroom, etc.) or in the direct vicinity of sources of heat.
- The base unit should not be installed/setup on or in the direct vicinity of large metallic objects or sources of electrical interference because this reduces the transmission range.

Examples of sources of interference

Metallic objects	Source of electrical interference
Radiators	Loudspeaker systems
Mirrors	Motors
Concrete steel walls	Unshielded electrical apparatus
Metal doors	

Preparing and Connecting the Base Unit

Power socket

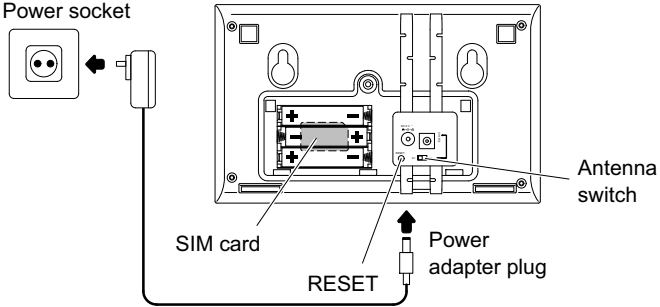

1. Use a screwdriver to loosen the screw in the battery and connection socket compartment on the underside of the base unit.
2. Remove the lid from the battery and connection socket compartment.
3. Slide the SIM card holder to the left to unlock it (A).
4. Pivot the holder up and insert the SIM card in the holder (B).
5. Pivot the holder with the SIM card back and slide the holder to the right to lock it (C)

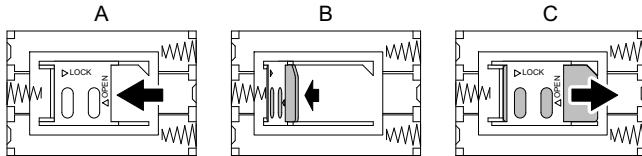



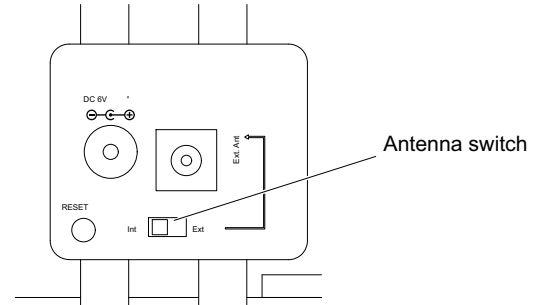

6. Insert three AAA alkaline batteries in the battery compartment (pay attention to correct polarity).
7. If the alarm system is to be operated without the external antenna (option), the antenna switch must be switched to the left and set to **Int.**



8. Connect the power adapter plug to the base unit.
9. Replace the lid on the battery and connection socket compartment.
10. Replace and tighten the screw.

Testing the GSM Telephone Dialling Unit

 **NOTE:** Test the GSM telephone dialling unit to ensure that the alarm function is activated via the mobile network.

1. Enter the device-specific Entry Code. Confirm it by pressing .
2. The menu is opened by pressing the Menu button  briefly.
3. Select the **Check SIM \$** menu option. Confirm it by pressing .
4. **SIM Service #** appears in the display.
5. Enter the number of your conventional phone or mobile phone. Confirm it by pressing . The number is dialed.
6. Take the call on your conventional phone or mobile phone.
7. Press  to end the call.

Positioning the Base Unit

It is possible to setup the device in a user-friendly, inclined position on a table or desk. To do this, insert the two legs (1) supplied in the recesses for the wall installation bracket (2) on the rear of the base unit.

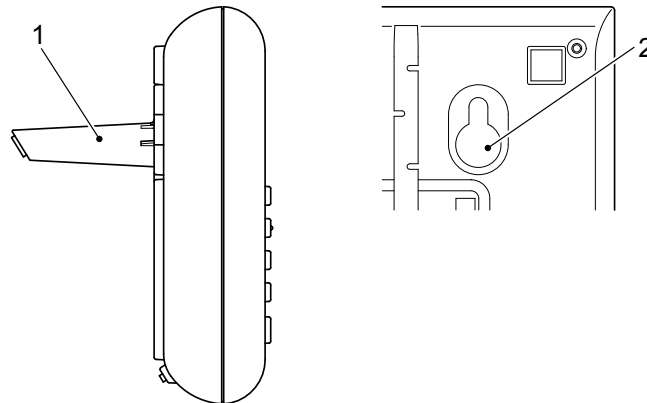

Wall Installation

After having found a suitable location for the base unit, you can begin with the installation.



WARNING:

Risk of fatal injury through electric shock or gas explosion. Pay attention that you do not damage electric cables or gas pipes.



NOTE:

Also pay attention to water pipes.

1. At the installation location, insert two screws in the wall, 100 mm apart and aligned horizontally. (It may be necessary to drill the holes first and then insert dowels in which to tighten the screws, depending on the properties of the wall.)
2. Screw the screws in the wall using a screwdriver until there is approx. 3 mm clearance from the bottom edge of the screw head to the wall.
3. Hook the base unit over the screws.
4. Connect the power adapter plug to a properly installed 230 V / 50 Hz power socket. The base unit is then ready to use.

Operating Elements and Indicators

Operating Elements and Indicators







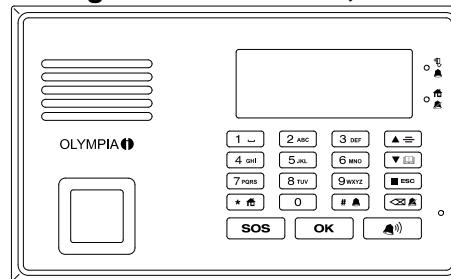

The base unit is equipped with an SOS (emergency call) button for emergency situations and a Panic button in the event of a direct threat. The wireless remote control unit is provided with a button which can be configured either as an Emergency Call or Panic button (refer to Configuring the Wireless Remote Control Unit).

Pressing the Panic button  triggers an immediate acoustic signal, intended as a deterrent, regardless of whether the alarm system is active or inactive. The acoustic alarm can be switched off via the base unit or the wireless remote control (refer to "Disarmed Mode" in Chapter "Monitoring Functions").

Pressing the button  activates the internal GSM telephone dialling unit, as long as phone numbers have been entered and stored beforehand (refer to "Configuring the internal GSM telephone dialling unit with OGM function"). The unit is activated regardless of whether the alarm system is armed or disarmed. The emergency call number is dialled first, then up to 10 stored phone numbers in succession. A voice message requests the subscriber answering to press the [1] button on their phone. The handsfree function is automatically activated on the base unit and enables communication between the caller and subscriber called.

Function Assignment to Buttons, Base Unit









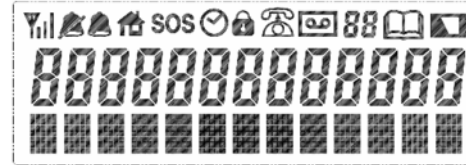

Button	Function
	Emergency Call button: Activates the internal GSM telephone dialling unit
	Confirmation
	Panic button: Triggers an acoustic alarm signal
	Open the menu; scroll up in the menu; increase the loudspeaker volume in Handsfree mode
	Open the Location Key function for phone numbers; scroll down in the menu; reduce the loudspeaker volume in Handsfree mode
	Disarmed mode: The system is deactivated; close the menu; stop the countdown
	Silent mode: The system is armed; when the alarm is tripped, the internal telephone dialling unit is activated; delete digits and letters
	Alarm mode: The system is activated; on burglary, the acoustic alarm signal and internal telephone dialling unit are activated

Operating Elements and Indicators



	At Home mode: The system is activated; on burglary: the acoustic alarm signal is issued
0-9, *, #	Digit keys: On pressing the # button >3 sec., a 2 sec. dialling pause is activated
*	In Text mode: Switch between upper and lower case
#	à á â Ç
0	+ & @ 0 / % * # \$ £ ¥ § ¿ i
1	Space - ? ! 1 , . : ; " ' < = > () { } _
2	A B C 2 Ä Æ Å à á â ç a b c 2 ä æ å à á â ç
3	D E F 3 è É ê ë d e f 3 è é ê ë
4	G H I 4 ï ï ï ï g h i 4 ï ï ï ï
5	J K L 5 € j k l 5 €
6	M N O 6 ñ ö ó ô õ m n o 6 ñ ö ó ô õ
7	P Q R S 7 ß p q r s 7 ß
8	T U V 8 ù ú û Ü t u v 8 ù ú û ü
9	W X Y Z 9 w x y z 9

Display Icons



Icon	Significance	Explanation
	Mobile network	Full signal, Weak signal, No signal
	Silent mode	If an alarm is triggered, no acoustic alarm is issued; internal GSM telephone dialling unit is activated.
	Alarm mode	If an alarm is triggered, an acoustic alarm is issued; internal GSM telephone dialling unit is activated.
	At Home Mode	If an alarm is triggered, an acoustic alarm is issued.
SOS	Emergency call	Internal GSM telephone dialling unit is activated.
	Time delay	Time delay is activated.
	Key lock	Key lock is activated.
	Internal GSM telephone dialling unit activated.	Connection is being made.
	Recording mode	Voice message is being recorded.

Operating Elements and Indicators





	Memory location-display.	Indicates the memory location of the phone number.
	Save icon	
	Battery indicator	Battery capacity of base unit is low.

Overview of LEDs

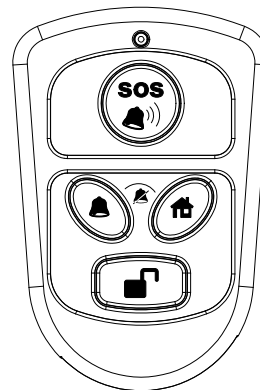
	With power supply		Without power supply	
	Top LED (red)	Bottom LED (yellow)	Top LED (red)	Bottom LED (yellow)
Silent mode	Lights up	Flashes	Off	Flashes
Alarm mode	Flashes	Off	Flashes	Off
At Home mode	Lights up	Lights up	Off	Lights up
Inactive mode	Lights up	Off	Off	Off

Function Assignment to Buttons, Remote Control



Button	Function
	Emergency call or panic function (can be optionally configured on the base unit)
	Alarm mode: On burglary, an acoustic alarm signal is issued and internal telephone dialling unit is activated
	At Home mode: On burglary, an acoustic alarm is issued
	Deactivate key lock on base unit; Stop alarm signal; Switch alarm system inactive.
	Silent mode activated on pressing the Alarm and At Home mode buttons simultaneously.

Menu Structure

	Review	Open Sensor01	Voice Record	
		Remote:1	Voice Record	
	Register	Search...	Open Sensor01	Voice Record
			Remote:1	Voice Record
	Trigger Delay	Duration	Delay: 0-240S	
		Trigger Tone	On	
			Off	
	Arming Delay	Delay: 0-240S		
	Flood & Smoke	Standard		
		Activate		
	Remote Key	Remote: SOS		
		Remote: PANIC		
	Entry Code	1234		

Menu Structure

Key Tone	Key Tone-On	
	Key Tone-Off	
Contrast	Contrast-1-5	
Language	Deutsch	
	Español	
	Nederlands	
	Dansk	
	Português	
	English	
	Français	
Date/Time	01-01-2010	00:00
Alarm period	Time:1-10Min	
Check SIM \$	SIM Service #	

Configuration







General Information

-  **NOTE:** Before beginning to operate the base unit, deactivate the key lock function. You need the 4-digit Entry Code to do this. The default, device-specific Entry Code is provided in the battery compartment of the base unit.

The key lock is reactivated automatically when no buttons are pressed for a period of 10 seconds. You can also activate the key lock function manually by pressing the  button.







The SOS and Panic buttons are excluded from the key lock function and are always functional!

Operation:

- The menu is opened by pressing the Menu button  briefly.
- Navigate through the menu using the arrow buttons  and .
- Confirm selections and entries by pressing the  button. If values are set in certain menus, they are accepted and saved.
- Text or numbers which have been entered can be corrected by pressing the  button.
- Press the  button briefly to move one menu level back.
- If no button is pressed for a period of 10 seconds, the menu is automatically closed and the key lock activated.





Selecting the Language

There is a range of languages available for selection:

1. Enter the device-specific Entry Code. Confirm it by pressing .
2. The menu is opened by pressing the Menu button  briefly.
3. Select the **Language** menu option. Confirm it by pressing .
4. Select the language required by pressing the  and  buttons.
5. Confirm it by pressing . The main menu reappears in the display.
6. Close the menu by pressing the  button.







Entry Code

Proceed as follows to change the Entry Code:

1. Enter the device-specific Entry Code. Confirm it by pressing .
2. The menu is opened by pressing the Menu button  briefly.
3. Select the **Entry Code** menu option. Confirm it by pressing . The default Entry Code appears in the display. The first digit flashes. Enter the 4-digit Entry Code.
4. Note your individual Entry Code down and keep it in a safe place.
5. Confirm it by pressing . The main menu reappears in the display.
6. Close the menu by pressing the  button.

Configuration

Setting the Date/Time

1. Enter the device-specific Entry Code. Confirm it by pressing .
2. The menu is opened by pressing the Menu button  briefly.
3. Select the **Date/Time** menu option. Confirm it by pressing .
4. Display: **01-01-2010**.
5. Use the keypad on the base unit to enter the day, month and year. Confirm it by pressing .
6. Display: **00:00**.
7. Enter the time as hour and minute.
8. Confirm it by pressing . The main menu reappears in the display.
9. Close the menu by pressing the  button.



Individual Outgoing Messages











NOTE:

You can record an individual message of up to max. 10 seconds for each sensor (door/window contact, smoke detector). The standard message is replaced by your individual voice message and played when the GSM telephone dialling unit is activated!

Proceed as follows to record an individual messages for each respective sensor:

1. Enter the device-specific Entry Code. Confirm it by pressing .
2. The menu is opened by pressing the Menu button  briefly.

3. Select the **Review** menu option. Confirm it by pressing .
4. Select the respective sensor required by pressing the  and  buttons. Confirm it by pressing .
5. The first letter of the sensor selected flashes. You can rename the sensor (e.g. BalconyDoor, KitchenWindow, etc.). Confirm it by pressing .
6. Text or numbers which have been entered can be deleted by pressing the .
7. **Voice Record** appears in the display. Confirm it by pressing .
8. Speak your individual voice message for the selected sensor into the unit (e.g. BalconyDoor).
9. Press the  button to confirm the message and end recording.



NOTE:

If you do not confirm it by pressing the  button, recording is automatically ended after 10 seconds.

10. Your individual voice message is played back. The main menu reappears in the display.
11. Close the menu by pressing the  button.

Activating the GSM Internal Telephone Dialling Unit with OGM Function

 **NOTE:** A SIM card must be installed in order to use the GSM telephone dialling unit.



The internal telephone dialling unit is deactivated if no telephone numbers have been entered and saved.

You can enter up to 10 individual telephone or mobile phone numbers of contact persons, such as relatives, friends or neighbours. In the event of an alarm, the internal GSM telephone dialling unit dials these phone numbers automatically in the sequence they were entered (beginning with memory location 0) and communicates the status via the voice messages assigned to the respective sensors. In the case of an "engaged" signal or no connection is possible, the next phone number is automatically dialled. A total of three dialling cycles are completed!

The internal GSM telephone dialling unit is deactivated when a subscriber called answers the call made and presses the numeric key [1] on his telephone or 3 dialling cycles have been completed.









 **NOTE:** Save as many phone numbers as possible. This increases the probability of reaching a contact person in the event an alarm is triggered. If, for example, you only save two phone numbers and both are engaged when the alarm call is sent, the dialling cycle soon comes to an end!

 **NOTE:** Do not forget to inform the contact persons that they will be called by your alarm system automatically if an alarm is triggered and agree on a sequence of actions if the alarm is triggered.

Memory locations 0-9 (buttons  to ) are available to enter up to 10 phone numbers. Each phone number can be composed of up to 24 characters/digits. In addition, a name with up to 13 characters/letters can be assigned to each phone number.



 **NOTE:** Unjustified requests for police, fire and rescue services are liable for costs!

Save the phone numbers as follows:

1. Enter the device-specific Entry Code. Confirm it by pressing .
2. Press the  button. **Location Key** appears in the display.
3. Select a memory location (button -). If you have not yet stored a phone number, **Empty** appears as information in the display. Confirm it by pressing .
4. Enter the phone number including the access code. Confirm it by pressing .
5. Enter the name associated with the phone number. Confirm it by pressing .
6. Press  to exit from the menu.

Configuration



After having entered phone numbers, ensure that they are correct in respect of the alarm calls. You can do this by triggering a silent alarm. The telephone numbers you have entered are dialled in succession in the programmed sequence.

1. Enter the device-specific Entry Code. Confirm it by pressing .
2. On pressing the  key, Silent mode is activated. Silent mode is indicated in the display by the  icon after the selected arming delay has expired.
3. Now trip the silent alarm on any of the door/window contacts (e.g. open door/window).





NOTE:

When Silent mode is active, there is no acoustic alarm signal. The display lights up yellow and indicates which sensor has been triggered. The internal GSM telephone dialling unit is activated after the trigger delay has expired.

- The subscriber called takes the call and the individual message recorded for the sensor triggered is played.
- The subscriber called is also requested to press digit key [1] on their telephone. The screening function is activated. This function enables the subscriber to screen the room in which the base unit is located.
- If the subscriber called does not initiate a function within 24 seconds, the next phone number is automatically dialled.
- Silent mode is deactivated by pressing the  button on the remote control, entering your Entry Code on the base unit and confirming by pressing the  button or when the subscriber called ends the call.

Saving an SOS (Emergency Call) Number







You can save an SOS (emergency call) number which is subsequently called first by pressing the  button on the base unit or, depending on the configuration, the  button on the remote control. Following this number, the other phone numbers stored, maximally 10, are called in succession (refer to "Activating the Internal Telephone Dialling Unit with OGM Function").

Save the SOS number as follows:



NOTE:

Unjustified requests for police, fire and rescue services are liable for costs!

1. Enter the device-specific Entry Code. Confirm it by pressing .
2. Press the  button. **Location Key** appears in the display.
3. Press the  button as the selected memory location. If you have not yet stored a phone number, **Empty** appears as information in the display. Confirm it by pressing .
4. Enter the phone number including the access code. Confirm it by pressing .
5. Enter the name associated with the phone number. Confirm it by pressing .
6. Press  to exit from the menu.

Trigger Delay

The alarm is triggered after a delay so that if someone enters through the main door, they can disarm the alarm system before the acoustic alarm signals and internal GSM telephone dialling unit are activated. You can set a trigger delay between 0 and 240 seconds.

If one of the sensors is tripped, the system must be switched to be disarmed for this period so that no alarm is triggered.

You can select whether an acoustic signal should be issued from the base unit during this period or not.

1. Enter the device-specific Entry Code. Confirm it by pressing **OK**.
2. The menu is opened by pressing the Menu button **▲≡** briefly.
3. Select the **Trigger Delay** menu option. Confirm it by pressing **OK**.
4. Select the **Duration** menu option. Confirm it by pressing **OK**.
5. Use the **▲≡** and **▼☰** buttons to set the required delay time.
6. Confirm it by pressing the **OK** button. The system returns to the previous menu level.
7. Select the **Trigger Tone** menu option. Confirm it by pressing **OK**.
8. Use the **▲≡** and **▼☰** buttons to select **Off** or **On**.
9. Confirm it by pressing the **OK** button. The system returns to the previous menu level.
10. Press **■ESC** to exit from the menu.

Arming Delay

You can set an activation delay between 0 and 240 seconds. The alarm system is armed after this period has expired. You must leave your apartment/house within this period through the door which will subsequently be monitored. An acoustic signal is issued by the base unit every second for the period of the set delay time.

1. Enter the device-specific Entry Code. Confirm it by pressing **OK**.
2. The menu is opened by pressing the Menu button **▲≡** briefly.
3. Select the **Arming Delay** menu option. Confirm it by pressing **OK**.
4. Use the **▲≡** and **▼☰** buttons to set the required delay time.
5. Confirm it by pressing **OK**. The main menu reappears in the display.
6. Press **■ESC** to exit from the menu.

Alarm Period

The base unit is equipped with an integrated siren. The duration of the acoustic alarm can be selected between a minimum of 1 minute to a maximum of 10 minutes. The alarm period is preset to 3 minutes (an alarm period up to 3 minutes is permitted in Germany).

1. Enter the device-specific Entry Code. Confirm it by pressing **OK**.
2. The menu is opened by pressing the Menu button **▲≡** briefly.
3. Select the **Alarm period** menu option. Confirm it by pressing **OK**.
4. Use the **▲≡** and **▼☰** buttons to set the required alarm period.
5. Confirm it by pressing **OK**. The main menu reappears in the display.
6. Press **■ESC** to exit from the menu.

Key Tone On/Off

It is possible to switch the key tone feature for the base unit on and off:

1. Enter the device-specific Entry Code. Confirm it by pressing **OK**.
2. The menu is opened by pressing the Menu button **▲≡** briefly.
3. Select the **Key Tone** menu option. Confirm it by pressing **OK**.
4. Use the **▲≡** and **▼☰** buttons to select the **Key Tone-On** or **Key Tone-Off** function.
5. Confirm it by pressing **OK**. The main menu reappears in the display.
6. Press **■ESC** to exit from the menu.

Setting the Display Contrast

The display contrast can be adjusted to one of five different settings:





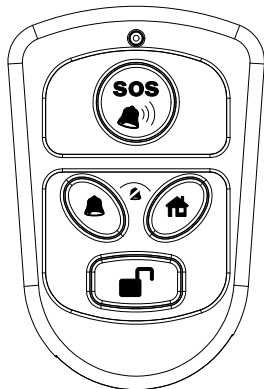

1. Enter the device-specific Entry Code. Confirm it by pressing **OK**.
2. The menu is opened by pressing the Menu button **▲≡** briefly.
3. Select the **Contrast** menu option. Confirm it by pressing **OK**.
4. Use the **▲≡** and **▼☰** buttons to adjust the contrast according to your needs.
5. Confirm it by pressing **OK**. The main menu reappears in the display.
6. Press **■ESC** to exit from the menu.

Remote Control









The  button on the remote control can be configured as an SOS (emergency call) or Panic button via the base unit.

Proceed as follows to configure the button:

1. Enter the device-specific Entry Code. Confirm it by pressing .
2. The menu is opened by pressing the Menu button  briefly.
3. Select the **Remote Key** menu option. Confirm it by pressing .
4. Use the  and  buttons to select the **Remote: SOS** or **Remote: PANIC** function.
5. Confirm it by pressing . The main menu reappears in the display.
6. Press  to exit from the menu.

Flood and Smoke Detectors

You can set-up the base unit so that flood and smoke detectors trigger an alarm when the base unit is disarmed.

1. Enter the device-specific Entry Code. Confirm it by pressing .
2. The menu is opened by pressing the Menu button  briefly.
3. Select the **Flood & Smoke** menu option. Confirm it by pressing .
4. Use the  and  buttons to select **Standard** or **Activate**.
5. Confirm it by pressing . The main menu reappears in the display.
6. Press  to exit from the menu.

The table below indicates how the flood and smoke detectors are triggered according to the various settings.

	Standard		Activate	
	Phone call	Alarm signal	Phone call	Alarm signal
Disarmed mode	No	No	Yes	Yes
At Home Mode	No	Yes	No	Yes
Silent mode	Yes	No	Yes	Yes
Alarm mode	Yes	Yes	Yes	Yes

Monitoring Functions

Overview of Monitoring Functions

Monitoring function	Acoustic alarm signal	Internal GSM telephone dialling unit activated.
Silent mode	No	Yes with screening function
Alarm mode	Yes	Yes
At Home mode	Yes	No
Disarmed mode	No	No
Emergency call (SOS)	No	Yes with handsfree function
Panic alarm	Yes	No

Switching the Monitoring Functions On/Off



NOTE:

Before switching any functions on, inform all the other people living in the residence regarding the location and method of operation of the wireless alarm system.



NOTE:

The alarm period of the acoustic alarm is restricted from a minimum of 1 minute to a maximum of 10 minutes depending on the configuration.

The wireless alarm system distinguishes between 4 types of alarm:

1.  **Alarm mode**

When Alarm mode is active and an alarm is triggered, an acoustic alarm signal is issued and the internal GSM telephone dialling unit is activated.

2.  **At Home mode**

When At Home mode is active and an alarm is triggered, only an acoustic alarm signal is issued.

3.  **Silent mode**

When Silent mode is active and an alarm is triggered, only the internal GSM telephone dialling unit is activated. A message requests the subscriber called to press the [1] button on their phone/mobile. The screening function is activated.

4. **Disarmed mode**

When Disarmed mode is set, the alarm system is deactivated.

The monitoring functions are confirmed by a voice message.



NOTE:

When triggered, the smoke detector always issues an acoustic alarm signal (immediately) regardless of the wireless alarm system! The response of the base unit depends on the type of alarm and setting defined in the Flood & Smoke menu option.



You can define the required type of alarm as follows using either the base unit or the remote control unit supplied:

-  **NOTE:** If an outdoor siren is registered on the base unit, the alarm can be stopped by the remote control unit after 15 seconds at the earliest.

Alarm Mode

-  **NOTE:** You should activate Alarm mode when you leave your apartment or house. Before doing so, check that all the doors and windows provided with a door/window contact are closed.

Base unit

1. Enter the device-specific Entry Code. Confirm it by pressing .
2. Press the  button.



Remote control

1. Press the  button.

At Home Mode

-  **NOTE:** During the night, when you are asleep, you should activate At Home mode. Before doing so, check that all the doors and windows are closed.

Base unit

1. Enter the device-specific Entry Code. Confirm it by pressing .
2. Press the  button.



Remote control

1. Press the  button.

Silent Mode

-  **NOTE:** When you leave your apartment or house, you can activate Silent mode instead of Alarm mode. Before doing so, check that all the doors and windows are closed.

Base unit

1. Enter the device-specific Entry Code. Confirm it by pressing .
2. Press the  button.

Remote control

1. Press the  and  buttons simultaneously.

Monitoring Functions

Disarmed Mode



NOTE: When alarm system is disarmed, you can move freely within the living quarters without triggering any alarms.



Base unit



1. Enter the device-specific Entry Code. Confirm it by pressing .

Remote control



1. Press the  button.

Panic Alarm



You can activate a panic alarm as a deterrent by pressing the  button on the base unit or the  button on the remote control unit, depending on the configuration. The panic alarm is triggered immediately without any delay.

To switch off the panic alarm, enter your 4-digit Entry Code on the base unit. Confirm it by pressing . Or, you can press the  button on the remote control.

Emergency Call (SOS)

You can trigger the SOS (emergency call) function by pressing the  button on the base unit or the  button on the remote control unit, depending on the configuration. The internal GSM telephone dialling unit is automatically activated when phone numbers have been stored. The emergency call number is dialled first, then up to 10 stored phone numbers in succession. A message requests the subscriber called to press the [1] button on their phone/mobile. The handsfree function is automatically activated and enables communication between the caller and subscriber called.

There are three ways to end the SOS function:

- a) Enter your 4-digit Entry Code on the base unit and confirm it by pressing the  button.
- b) Press the  button on the remote control.
- c) The subscriber called takes the call, executes a function within 24 seconds (refer to "Activating the Internal Telephone Dialling Unit with OGM Function") and then ends the call.

Remote Access Via Telephone

The wireless alarm system can be operated by remote access using a telephone. You can use a telephone to activate or deactivate the alarm system and switch the handsfree and screening functions on.

Proceed as follows to operate your alarm system by remote access using a telephone:

1. Dial the mobile phone number of the SIM card installed in the alarm system.
2. Wait until the alarm system takes the call following the eighth ring. You will hear a long acoustic signal.



NOTE: As soon as a connection is established with the alarm system, "Remote..." appears in the base unit's display.

3. Enter your 4-digit Entry Code.
4. When you enter the code correctly, you hear 2 short acoustic signals. If you enter the code incorrectly 3 times, the connection is interrupted.
5. Use the keypad on your telephone to execute the following functions (refer to table). The monitoring functions are confirmed by a voice message.

Key	Function
[1]	Activate the handsfree function
[2]	Activate the screening function (in the room)
[3]	Activate Alarm mode
[4]	Activate At Home mode
[5]	Activate Silent mode
[6]	Activate Disarmed mode
[#]	End the handsfree or screening function
[*], [#]	End the remote access via telephone facility

6. Remote access to your alarm system is interrupted when you press the [#] button twice on your telephone.

Resetting the Factory Settings (RESET)

Resetting the Factory Settings (RESET)



NOTE: Please note that when carrying out a RESET, all the user settings are deleted. The registration of the sensors is retained! After a RESET has been executed, the 4-digit Entry Code is 1-2-3-4!

Proceed as follows to reset the factory settings on the wireless alarm system:

1. Use a screwdriver to loosen the screw in the battery and connection socket compartment on the underside of the base unit.
2. Press the RESET button. The alarm system acknowledges a RESET by means of an acoustic signal.
3. Close the battery and connection socket compartment and tighten the screw.

Registering and Deregistering Sensors / System Extension

Registering Sensors

Up to 32 sensors can be registered on the wireless alarm system.

If you purchase optionally available sensors, such as additional remote controls, smoke detectors etc., they must be registered manually.

Proceed as follows to register the sensors:

1. Enter the device-specific Entry Code. Confirm it by pressing **OK**.
2. Press the **▲≡** button to open the menu. Use the **▲≡** and **▼☰** buttons to select the **Register** menu option. Confirm it by pressing **OK**.
3. **Search...** appears in the display.
4. Activate the sensor to be registered. To do this, please refer to the description supplied with the sensor.
5. **Open Sensor01** or **SmokeSensor01**, for example, appears in the display. You can rename the sensor, if necessary. Confirm it by pressing **OK**.
6. **Voice Record** appears in the display. Press **■ESC** to retain the standard message or press **OK** to record an individual message.
7. Confirm it by pressing **OK**.

 **NOTE:** If you do not confirm it by pressing the **OK** button, recording is automatically ended after 10 seconds.

8. Your individual message is played back. The main menu reappears in the display.

Deregistering Sensors

1. Enter the device-specific Entry Code. Confirm it by pressing **OK**.
2. Press the **▲≡** button. **Review** appears in the display.
3. Press the buttons **▲≡** and **▼☰** to select the sensor to be deregistered.
4. Press the **☒▲** button. **Delete?** appears in the display.
5. Confirm it by pressing **OK**. **Empty** appears in the display.
6. Press the **■ESC** button twice to exit from the menu.

System Extension

You can order accessories and options for the wireless alarm system via the following web site

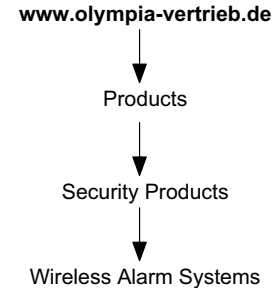

Changing the Batteries

Changing the Batteries

If the battery charge of the sensors is low or practically empty, one of the following status messages appear in the display:

Battery capacity low

1. **bAtt Lo** appears in the display. The sensor in question, e.g. **Open Sensor01** is indicated.
2. If you activate the alarm system, 5 successive, short acoustic signals are issued.



NOTE: Change the batteries!

Battery charge empty

1. **bAtt off** appears in the display. The sensor affected, e.g. **Open Sensor01** is indicated.
2. If you activate the alarm system, 5 successive, short acoustic signals are issued.



NOTE: Change the batteries! A connection between the sensor and base unit is no longer guaranteed!

Remote Control

1. Use a precision screwdriver to loosen the screw in the battery compartment on the underside of the remote control unit.
2. Remove the cover of the battery compartment.
3. Remove the battery contained.
4. Insert a new CR2430 3 V lithium battery in the battery compartment (ensure correct polarity).
5. Replace the cover on the battery compartment.
6. Replace and tighten the screw.

Base Unit

The  icon in the display indicates a low battery capacity in the base unit. Change the batteries!

1. Use a screwdriver to loosen the screw in the battery and connection socket compartment on the underside of the base unit.
2. Remove the lid from the battery and connection socket compartment.
3. Remove the batteries contained.
4. Insert three new AAA alkaline batteries in the battery compartment (pay attention to correct polarity).
5. Replace the lid on the battery and connection socket compartment.
6. Replace and tighten the screw.

Regular Maintenance and Servicing

Base Unit

1. Disconnect the base unit from the power outlet before cleaning it!
2. Clean the surface of the housing with a soft, lint-free cloth. Never use any chemicals or scouring agents.



NOTE: Never immerse the equipment in water!

Information on Disposal

Information on Disposal

The implementation of European law in national laws and directives obliges you to dispose of consumable goods appropriately. This serves to protect both persons and the environment. The adjacent symbol indicates that electrical and electronic apparatus and batteries no longer required must be disposed of separate from normal household waste.

Old or unwanted devices must be disposed of at collection points provided by public waste authorities.

Batteries and power packs must be disposed of at shops which sell batteries or collection points which provide the corresponding containers.

Packaging materials must be disposed of according to local regulations.



Technical Data

The wireless alarm systems in the Protect 9XXX-Series operate within the frequency band specially reserved for security technology in the 868 MHz frequency range. This ensures that interference to the wireless alarm system by other consumer products, such as baby monitors, is ruled out. However, it cannot be ruled out that the radio transmission suffers intermittent or continuous interference due to defective components of other electrical or electronic products, such as ventilators and antenna amplifiers. In addition, radio transmission can be subject to interference from external sources with wilful intent.

Base Unit

Weight: 228 g (without batteries)
Dimensions (WxHxD): (172 x 105 x 31) mm
Frequency: 868 MHz
Battery: 3 AAA alkaline
Power adapter plug: 6 V_{AC}, 1 A
Number of sensors: Max. 32

Remote Control

Weight: 24 g
Dimensions (WxHxD): (40 x 60 x 14.5) mm
Frequency: 868 MHz
Battery: Lithium CR2430 3 V

Technical Modifications

This operating instruction manual serves purely for information purposes. Its content is not part of any contract for sale.

All the data relates to nominal values. The equipment and options described may differ from country to country according to national requirements.

CE-Mark

CE Mark

The device fulfils the requirements stipulated in the EU Directive:

- 1999/5/EC (R&TTE)

The CE Mark on the device confirms conformity.

Empty Page

Empty Page

Empty Page

Entry Code

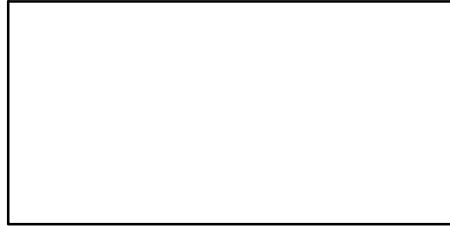

This is your individual, device-specific Entry Code!

If you want to change this predefined Entry Code, please refer to Chapter "Configuration" in this operating instruction manual.

Keep this operating manual in a safe place away from the wireless alarm system!

Please note that the Copyright of this operating instruction manual is by Olympia and, therefore, must not be further copied, published or sold in any form.
The information contained in the operating instruction manual is only intended for personal use.



All rights reserved.